

## FLEX Series

Refrigerated Type Compressed Air Dryers

Models: DFX 1.1, DFX 1.2, DFX 1.5, DFX 2.1, DFX 3.1, DFX 4.1, DFX 4.5, DFX 5.5

FORM NO.: 7440063 REVISION: 06/2017

READ AND UNDERSTAND THIS MANUAL PRIOR TO OPERATING OR SERVICING THIS PRODUCT.



## Contents

INTRODUCTION .....	1
SAFETY .....	1
INSTALLATION .....	1
HOW IT WORKS .....	3
OPTI-ECO CONTROLLER .....	4
START-UP/OPERATION.....	5
MAINTENANCE.....	6
FIELD SERVICE GUIDE.....	7
ENGINEERING DATA .....	8, 9
DRAWINGS	
General Arrangement	
Model: DFX 1.1 .....	10
Model: DFX 1.2 .....	11
Models: DFX 1.5, DFX 2.1 .....	12
Models: DFX 3.1, DFX 4.1 .....	13
Models: DFX 4.5, DFX 5.5 .....	14
Electrical Schematic	
Models: DFX 1.1, DFX 1.2 (115V/1PH/60Hz) .....	15
Models: DFX 1.5, DFX 2.1, DFX 4.1 (230V/1Ph/60Hz) .....	16
Models: DFX 3.1, DFX 4.5, DFX 5.5 (460V/3Ph/60Hz) .....	17
Air and Refrigerant Flow Schematic .....	18
REPLACEMENT PARTS.....	19
MAINTENANCE KITS .....	20
WARRANTY	

## INTRODUCTION

Compressed air is generated by compressing atmospheric air of which contains moisture and other containments, into high pressure air. After compression, the air is not saturated but when it is cooled by the aftercooler, the RH remains 100%.

If it travels down the pipe line and cools further, moisture starts to condensate into liquid water. Condensate water in the pipe line is harmful to the manufacturing process as it causes rust or sludge etc.

In order to avoid this problem, the only solution is to dry the compressed air with an air dryer. Refrigerated compressed air dryers are used as a cost effective and energy efficient solutions for eliminating moisture from the compressed air system.

SPX's discovery of using Phase Change Material (PCM) as a component in the refrigerated compressed air dryer to produce latent heat has encouraged great energy savings. Through latent heat properties, it is able to save up to 99% of energy at no load condition. This is indeed a breakthrough in refrigerated compressed air dryer technology.

## SAFETY

The dryers are designed and built with safety as a prime consideration; industry accepted safety factors have been used in the design. Each dryer is checked at the factory for safety and operation. All necessary adjustments are made before shipment.

Follow the maintenance schedules outlined in this manual for good performance and safe operation.

Only qualified personnel with proper tools should do maintenance.

Safety instructions in this manual used to indicate hazard seriousness levels are classified as follows:

### **▲ DANGER**

Immediate hazard which WILL result in severe injury or death.

### **▲ WARNING**

Hazard or unsafe practice which COULD result in severe injury or death.

### **▲ CAUTION**

Hazard or unsafe practice which COULD result in minor injury or product damage.

### **▲ WARNING**

Carefully read the following safety rules before proceeding with installation, operation or maintenance. The rules are essential to ensure safe dryer operation. Failure to follow these rules may void the warranty or result in dryer damage or personal injury.

1. Do not install or try to repair a dryer that has been damaged in shipment. See Receiving and Inspection for instructions.
2. Compressed air and electricity have the potential to cause personal injury or equipment damage. Before doing any work on the dryer, be sure the electrical supply has been locked and tagged and the internal pressure of the dryer has been vented to the atmosphere.
3. Do not operate the dryer at pressures or temperatures above the maximum conditions shown on the data plate.
4. Always supply electrical power that complies with the voltage shown on the data plate.
5. Do not readjust the dryer without factory authorization.
6. Do not operate the dryer with any dryer cabinet panel removed.

### **▲ WARNING**

Cooling air flow across the condenser may be reduced if a dryer panel has been removed while the dryer is operating, resulting in the dryer not functioning properly and/or dryer failure. Failure to follow these instructions may result in a non-warrantable dryer failure.

7. Only a competent refrigeration mechanic works on the refrigeration system.
8. Use only manufacturer's genuine replacement parts. The manufacturer bears no responsibility for hazards caused by the use of unauthorized parts.

## INSTALLATION

Inspect the dryer closely when it is received. Record any indication of damage on the delivery receipt, especially if the dryer will not be immediately uncrated. Obtain the delivery person's signed agreement to recorded damages to facilitate future insurance claims .

Since the dryer is shipped F.O.B. Factory, the manufacturer's responsibility for the shipment ceases when the carrier signs the bill of lading.

If goods are received short or in damaged condition, notify the carrier and insist on a notation of the loss or damage across the face of the freight bill. Otherwise no claim can be enforced against the carrier.

If concealed loss or damage is discovered, notify your carrier at once and request an inspection. This is absolutely necessary. Unless you do this, the carrier will not consider any claim for loss or damage. The carrier will make an inspection and may grant a concealed damage notation. If you give the carrier a clear receipt for the goods that have been damaged or lost in transit, you do so at your own risk and expense.

The manufacturer is willing to assist you in collecting claims for loss or damage. Willingness does not make the manufacturer responsible for collecting claims or replacing material. Claim filing and processing is your responsibility.

## Ambient Air Temperature

Locate the dryer indoors where the ambient air temperature will be between 39°F (4°C) and 122°F (50°C). Intermittent operation at ambient temperatures up to 122°F (50°C) will not damage the dryer but may result in a higher dew point or dryer shutdown due to high refrigerant discharge pressure (see Field Service Guide). Call your local distributor if prolonged operation at ambient temperatures above 122°F (50°C) or below 39°F (4°C) is unavoidable.

Do not operate air-cooled dryers at ambient air temperatures below 39°F (4°C). Such operation may result in low suction pressure, causing freeze-up.

## Location and Clearance

Mount the dryer on a level base and bolt down if the base vibrates. If the dryer is air cooled, install it in a clean, well-ventilated area to reduce fouling of the condenser coils with dirt and dust.

Allow 39 inches (1000 mm) clearance on the sides and the front of the dryer for cooling airflow on air-cooled dryers and for service access on air-cooled dryers.

## System Arrangement

Liquid water adversely affects dryer performance. To prevent "slugging" the dryer with liquid water, locate the dryer downstream of an after cooler and a mechanical separator. Install drain valves to discharge condensate that collects in these areas.

If the airflow is relatively constant and will not cause short term overloading of the dryer, it is recommended that the dryer be located downstream of the receiver tank. If the nature of the application is such that the air demand regularly exceeds the dryer flow rating, it is recommended that the dryer be located upstream of the receiver.

For safety and convenience, install inlet and outlet shutoff valves and depressurization valves at the locations indicated. These valves allow the dryer to be isolated and depressurized for servicing. Bypass piping may be installed around the dryer for uninterrupted airflow when the dryer is serviced. If the compressed air operation cannot tolerate wet air for short periods, install a second dryer in the bypass line.

Compressed air systems commonly require filters to remove compressor oils, particulates, condensed liquids and other contaminants. When an oil-removal filter is used, install the filter downstream of the dryer. At this location, the life of the replaceable filter element is prolonged since the dryer removes some of the entrained oil and drained through the separator.

## Piping and Connections

The user must furnish piping unless otherwise specified. Connections and fittings must be rated for the maximum operating pressure given on the dryer data plate and must be in accordance with applicable codes. Support all piping; do not allow the weight of any piping to stress the dryer or filters. Inlet and outlet shutoff valves and bypass valves are recommended. Piping should be at least the size of the inlet and outlet connections to minimize pressure drop in the air system. See Specification Table for dryer inlet and outlet connections.

## Drains

Condensate must be drained from the dryer to prevent an influx into outlet air. The FLEX dryers are equipped with an automatic no loss drain valve and internal drain hoses up to the drain connections on the dryer cabinets.

The automatic no loss drain valve uses two electrostatic capacity sensors (high level, low level), so any condensate from compressed air can be sensed correctly and discharged. Therefore, the FLEX dryer can protect energy loss by discharging condensate selectively.

The user must install a discharge line from the drain connection and run it to a waste disposal collection system that meets applicable regulations. Pipe or copper tubing 1/2 inch or larger is recommended for condensate discharge lines. Install the drain lines so that condensate can be seen as it drains.

**NOTE:** Discharge is at system pressure. Drain line should be anchored.

**NOTE:** Condensate may contain oil. Comply with applicable laws concerning proper disposal.

## Drain Valve Operation

- A. Verify that isolation valves are open. If the drain fails to discharge after the valve is energized, the electronic control circuit will repeatedly energize the valve in an attempt to clear the discharge port. If, after 60 seconds, the drain still fails to discharge, the control circuit then switches to the alarm mode. In this mode the valve is de-energized and the red alarm light is activated on the drain. The valve is then automatically energized every 4 minutes for 5 seconds. Check the drain operation. Push drain (push-to-test) button on the drain or the Electronic Controller (if equipped) to energize drain. A flow of condensate and/or air should be present at the drain outlet. The alarm mode automatically clears after the drain returns to normal operation.
- B. The condensate flows through the feed line (1) into the condensate drain and accumulates in the housing (2). A capacitive sensor (3) continuously registers the liquid level. As soon as the container is filled, a fixed waiting period begins during which more condensate accumulates. After the waiting time has expired the pilot valve (4) is then activated and the diaphragm (5) opens the outlet line (6) for discharging the condensate.

When the condensate drain has been emptied, the outlet line is closed again quickly and tightly without wasting compressed air.

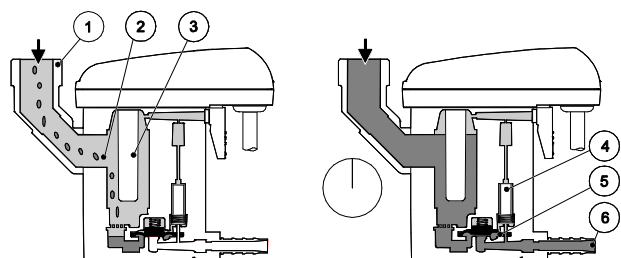

Figure 1.  
Schematic diagram of the no loss drain valve

**Electrical Connections**

**⚠ WARNING**

Operation of dryers with improper line voltage constitutes abuse and could affect the dryer warranty.

The dryers are constructed according to NEMA Type 1 electrical standards. Field wiring must comply with local and national fire, safety and electrical codes. Installation must be in accordance with the National Electrical Code. Confirm that your line voltage is the same as the voltage listed on the dryer data plate. Refer to Figures 6A, 6B, and 6C electrical schematics.

**Electronic Over Current Relay (EOCR)  
Models DFX 3.1, DFX 4.5, and DFX 5.5**

**⚠ CAUTION**

If the refrigerant compressor is tripped during dryer operation, or an "E01" error code is displayed in the LCD window, check the High Pressure Switch or EOCR in the electric box. Red and green fault LEDs on the EOCR may be used to check the status of the compressor motor circuit.

- A. **In case of overcurrent**, the red fault LED will illuminate and flicker at 0.4 second intervals if overcurrent is detected during motor operation. If the motor contactor is tripped, the red fault LED will illuminate solid.
- B. **In case of phase unbalance**, the red fault LED will illuminate and flicker at 0.4 second intervals if the phase unbalance rate is over 50%.
- C. **In case of phase failure**, the motor contactor is tripped within 3 seconds of a phase failure in three (3) phase load.
- D. **In case of reverse phase**, the red and green fault LED's will flicker alternately.

Refer to the following table for further information.

	Condition	LED Status	LED Diagram	
Operating status	Normal	LED OFF	—————	
	Over current	0.4 Second intervals		
	Phase unbalance (30-50%)	0.4 Second intervals		
Tripped status	Over current	O.L LED light up	—————	
	Phase failure (3CT)	R	1 time for 3 seconds	
		S	2 time for 3 seconds	
		T	2 time for 3 seconds	
	Reverse phase (3CT)	Red & Green color LED flicker alternately		

**HOW IT WORKS**

**Phase Change Mechanism of the FLEX Dryer**

1. When the refrigeration compressor and the condenser fan are running, the cold refrigerant in the chiller (evaporator) cools the liquid Phase Change Material (PCM) which gradually solidifies.
2. When the PCM is sufficiently cooled and solidified, the refrigeration compressor and condenser fan will stop.
3. The compressed air is continuously cooled by the PCM while the refrigeration compressor is inactive. No power is consumed during this period.
4. The PCM gradually liquefies as it adsorbs heat from the compressed air, and when fully melted, the refrigeration compressor and condenser fan resume to cool the PCM.

**Compressed Air flow**

The dryers use refrigeration cooling to condense entrained moisture out of the air stream. Warm saturated air enters the air-to-air heat exchanger where it is cooled by outgoing cold air. The inlet air is further cooled in the refrigeration chiller. The condensate is removed from the air stream by an electronic drain valve.

The cold, dry air is reheated by incoming warm air as it passes back through the air-to air heat exchanger. Using the outgoing air to pre-cool the inlet air condenses up to 65 percent of the moisture out of the inlet air before it reaches the chiller. Pre-cooling the inlet air reduces the heat load on the refrigerant compressor, permitting the use of a smaller refrigerant compressor.

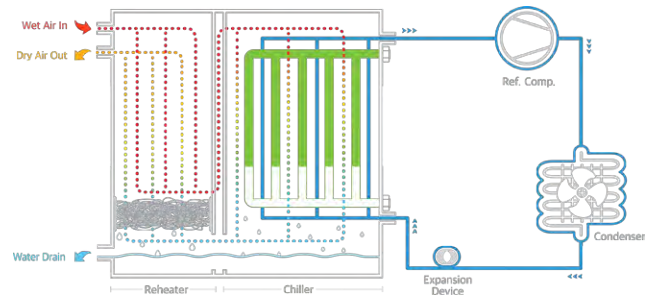
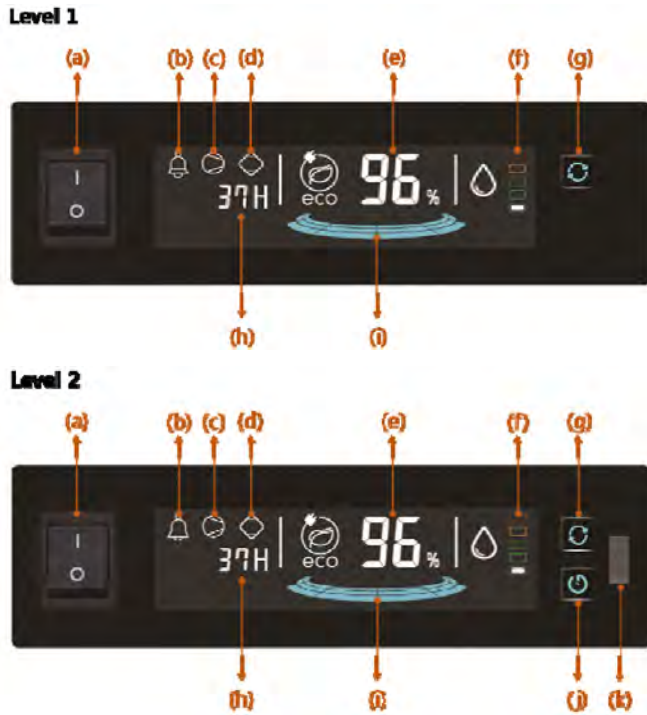

**Figure 2.**  
Schematic diagram of the compressed air flow and refrigerant

**OPTi-ECO CONTROLLER**

There are two kinds of OPTi-Eco Controller, the Level 1 has basic functions while the Level 2 has advanced functions like communication and operating status data storage.

The Level 1 OPTi-Eco Controller is standard for models DFX 1.1 and DFX 1.2. The Level 2 version is standard for models DFX 1.5, DFX 2.1, DFX 3.1, DFX 4.1, DFX 4.5 and DFX 5.5.



**Figure 3.**  
**OPTi-Eco Controller**

- a: DRYER ON/OFF SWITCH
- b: ALARM LIGHT
- c: REFRIGERANT COMPRESSOR RUNNING LIGHT
- d: DRYER RUNNING LIGHT
- e: ENERGY SAVING RATIO (%)
- f: DEWPOINT TEMPERATURE INDICATOR
- g: RUNNING TIME SELECT BUTTON
- h: DRYER RUNNING / REFRIGERANT COMPRESSOR RUNNING TIME
- i: ENERGY SAVING (GRAPH)
- j: TIMER BUTTON (LEVEL 2 ONLY)
- k: MICRO-USB CONNECTION PORT (LEVEL 2 ONLY)

**Functions**

1. OPTi-Eco Controller (Level 1, Basic function)
  - (i) Dryer On/Off
  - (ii) Display energy saving ratio (%)
  - (iii) Display alarm signal
  - (iv) Display dryer and refrigerant compressor running time
  - (v) Display dew point level by indicator

2. Additional functions (Level 2)
  - (i) Save the operating data
    - a. Refrigerant compressor on/off status, Alarm, Dew point level, Inlet air temperature
    - b. Memory chip can save maximum 30 days
    - c. When there is no space to save, then erase the first one
  - (ii) MICRO-USB connection port
    - a. Automatically download operating data
    - b. Automatically upgrade firmware program
  - (iii) Communication port
    - a. Bluetooth monitoring (Option)
    - b. RS485: Modbus monitoring (Option)

**Operation**

1. OPTi-Eco Controller indicates the energy saving %, dryer's operating time, refrigeration compressor's operating time and dew point level.
2. To start the FLEX dryer, turn on the (a) dryer on/off switch.
3. When the refrigeration compressor and the condenser fan are running, the cold refrigerant in the chiller (evaporator) cools the liquid Phase Change Material (PCM) which gradually solidifies. During this time, the refrigeration compressor running light (c) is illuminated on the LCD window.
4. Energy saving percent (e) is displayed on the LCD window by calculating dryer running time and refrigeration compressor operating time.
5. Pressure dew point level (f) is displayed on the LCD window.
6. Dryer running time (h) is displayed on the LCD window, when the power on or dryer running time select button (g) is pressed, then refrigerating compressor running time is displayed. When the (j) button is pressed over 10 seconds, dryer running time is erased and displayed "0 H". (timer reset)
7. Check the dryer operating status when the alarm light (b) blinks according to Table 1 below.

No.	Alarm display	Description
1	lamp (b) blinks rapidly and "E01" is displayed on (h)	Ref. compressor has no signal
2	lamp (b) blinks and "E02" is displayed on (h)	Temperature sensor signal open
3	lamp (b) light is on "E03" is displayed on (h)	Drain valve has some trouble

**Table 1. Alarm display mode**

## START-UP/OPERATION

### **⚠ DANGER**

Never use the disconnect switch to shut down the dryer for an extended period of time (except for repair). Failure to follow these instructions may result in a non-warrantable compressor failure.

**IMPORTANT:** For models DFX 1.5 through DFX 5.5, energize dryer for 24 hours prior to starting refrigerator compressor! Failure to follow these instructions may result in a non-warrantable compressor failure.

Follow the procedure below to start your dryer. Failure to follow the prescribed start-up procedure will invalidate the warranty. If problems arise during start-up, call your distributor. Before repair, vent the internal pressure of the dryer to atmospheric pressure.

### Before starting dryer

Drain connections must be made before the dryer can be operated. The dryers are fully automatic and require no auxiliary controls.

1. Turn the dryer on/off switch to off.
2. Check that the main electrical supply voltage matches the voltage specified on the dryer data plate.
3. Check proper connection and support of compressed air lines to the dryer; check bypass valve system, if installed.
4. SLOWLY pressurize the dryer. The outlet valves of the dryer should be closed to prevent flow through the dryer.
5. Turn on the main electrical power to the dryer.
6. Ensure adequate ventilation for air cooled dryers.
7. Do not operate the dryer with any dryer cabinet panel removed.

### **⚠ WARNING**

Cooling air flow across the condenser may be reduced if a dryer panel has been removed while the dryer is operating, resulting in the dryer not functioning properly and/or dryer failure. Failure to follow these instructions may result in a non-warrantable dryer failure.

### To start dryer

**IMPORTANT:** For models DFX 1.5 through DFX 5.5, energize dryer for 24 hours prior to starting refrigerator compressor! Failure to follow these instructions may result in a non-warrantable compressor failure.

1. Turn the power switch to ON. The refrigerant compressor will turn on.
2. Allow the dryer to run 15 minutes. Confirm that the temperature indicators are in the green zone.
3. SLOWLY open the dryer outlet valves permitting flow through the dryer.
4. Confirm that condensate is discharging from the drain valve by pressing the "Push-to Test" button.
5. Confirm that the inlet air temperature, pressure and airflow to the dryer meet the specified requirements (see Engineering Data section).

6. Confirm that the condensate lines from the drain valve discharge into a collection tank or an environmentally approved disposal system.

The FLEX dryer is designed to run and stop repeatedly. Let the FLEX dryer operate even when the demand for compressed air is interrupted; the FLEX dryer will not freeze up.

### Shutdown

When the dryer must be shutdown for maintenance or other reasons, use the following procedure.

1. Turn off the power switch.
2. Disconnect the main power supply.
3. Lock out and tag the power supply in accordance with OSHA requirements.

If mechanical repairs are to be made or service is performed, vent the internal pressure of the dryer to atmospheric pressure. Restart the dryer according to the start-up instructions.

### **⚠ WARNING**

Disconnect power supply and depressurize dryer before servicing. Dismantling or working on any component of the compressed air system under pressure may cause equipment failure and serious personal injury.

**MAINTENANCE**

The FLEX Dryer requires little maintenance for satisfactory operation. Good dryer performance can be expected if the following routine maintenance steps are taken.

**General**

For continued good performance of your refrigerated dryer, all refrigeration system maintenance should be performed by a competent refrigeration mechanic.

**NOTE:** Before corrective maintenance is done during the warranty period, call your local distributor and proceed according to instructions. Refer to the warranty for limits of your coverage.

**Daily Maintenance**

Check the operation of the no loss drain valve at least once daily. See the Field Service Guide for remedies to drain valve malfunctions.

**Monthly Maintenance**

It is recommended to inspect the condenser coils monthly. If necessary, remove dirt or other particles with compressed air from an OSHA-approved air nozzle that limits its discharge pressure to 30 psig (2.1 kgf/cm<sup>2</sup>).

**Yearly Maintenance**

It is recommended to replace the drain service unit annually. For units purchased with mounted filtration, replace prefilter and afterfilter elements annually. Maintenance kits are available to facilitate annual maintenance.

Models: DFX 1.1, DFX 1.2, DFX 1.5, DFX 2.1, DFX 3.1, DFX 4.1

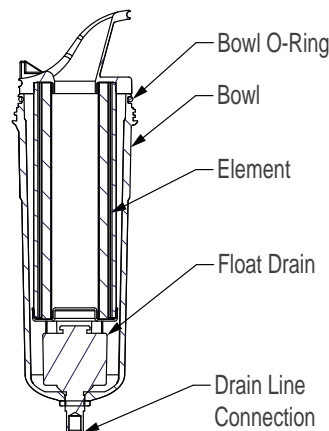
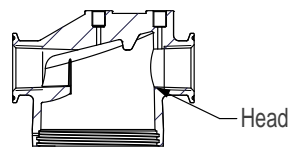

Models: DFX 4.5, DFX 5.5

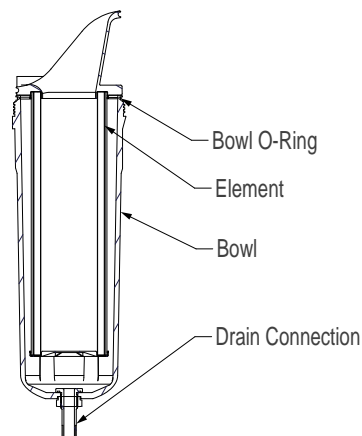
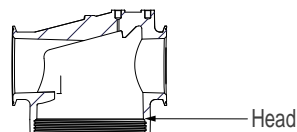

**Figure 4.**  
**Mounted Filtration**

**FIELD SERVICE GUIDE**

<b>PROBLEM</b>	<b>SYMPTOM</b>	<b>POSSIBLE CAUSE</b>	<b>REMEDY</b>
<b>Water downstream of dryer.</b>	No discharge from no loss drain valves.	Drain valve failure or accumulation of dirt in drain valve strainer.	Dismantle drain valve: clean, repair or replace. See maintenance section.
	Inlet air temperature is too high.	Aftercooler malfunction.	Check aftercooler discharge temperature. Reduce temperature to 122°F (50°C) max.; reduce airflow if temperature is above 95°F (35°C).
	Liquid water entering dryer.	Aftercooler drain valve malfunction.	Dismantle aftercooler drain valve; clean, repair or replace.
	Excessive airflow (may also cause high pressure drop).	Dryer improperly sized.	Check airflow and dryer capacity (See Engineering Data Tables). Reduce airflow or resize and replace dryer.
	Compressor cuts out on internal overload.	Inadequate ventilation of refrigerant compressor.	Ensure adequate ventilation of the condensing unit (see Clearance). Motor will restart automatically when compressor is cool.
		Leak in refrigeration system.	Locate leak, repair and recharge. Motor will restart automatically when compressor is cool.
	Compressor windings read open or shorted.	Compressor burned out.	Have a refrigeration mechanic check and replace.
	The dew point level is red on LCD window.	Inlet air temperature too high.	Reduce aftercooler discharge temperature to design conditions (See Engineering Data Tables).
		Excessive airflow.	Check airflow and system capacity. Reduce airflow or resize and replace system.
		Condenser fouled or clogged.	Clean or replace condenser.
		Fan motor inoperative.	Replace fan motor.
		High ambient temperature.	Ventilate area. See Engineering Data Tables.
<b>High pressure drop across dryer.</b>	Inlet air temperature is too low.	Low ambient temperature.	Consult your local distributor.
	Excessive airflow (may also cause water downstream of dryer).	Dryer improperly sized.	Check airflow and dryer capacity. Reduce airflow or resize and replace dryer.
	Dryer icing up.		Adjust operating conditions to meet sizing conditions.
<b>No condensate from no loss drain valve.</b>	Valve venting. But no condensate from valve.	Accumulation of dirt in valve strainer.	Dismantle valve strainer. Strainer clean or replace.
	Valve continuously venting.	Clogged valve orifice.	Replace valve.
		Short in electrical component.	Check and replace connector or OPTI-ECO controller assembly.
	Valve not cycling.	No electrical power.	Check and correct power supply and connections.
		Drain valve malfunction.	Replace drain valve.
	No response when test button is pushed.	No electrical power.	Check and correct power supply and connections.
Burn out fuse.		Check solenoid coil and wiring cable and replace fuse.	

**ENGINEERING DATA****SPECIFICATIONS**

MODEL	Rated Capacity <sup>1</sup> (scfm)	Inlet /Outlet Connections	Dimensions - inches (mm)			Net Weight lbs (kg)
			Height	Width	Length	
DFX 1.1	75	NPT 1"	29.6 (751)	14.3 (363)	23.7 (603)	120 (54.5)
DFX 1.2	100	NPT 1"	28.0 (711)	14.3 (363)	30.7 (781)	147 (66.5)
DFX 1.5	150	NPT 2"	30.0 (761)	17.4 (443)	35.5 (901)	189 (85.5)
DFX 2.1	200	NPT 2"	30.0 (761)	17.4 (443)	37.8 (961)	217 (98.5)
DFX 3.1	300	NPT 2"	35.9 (911)	19.4 (493)	43.7 (1,111)	324 (147)
DFX 4.1	400	NPT 2"	35.9 (911)	19.4 (493)	43.7 (1,111)	335 (152)
DFX 4.5	450	NPT 2"	40.6 (1,032)	19.5 (494)	49.3 (1,253)	366 (166)
DFX 5.5	550	NPT 2"	40.6 (1,032)	19.5 (494)	49.3 (1,253)	396 (180)

<sup>1</sup> Rated Flow Capacity - Conditions for rating dryers are in accordance with ISO 7183 (Option A2).

Compressed air at dryer inlet: 100 psig (6.9 barg) and 100°F (38°C); ambient air temperature: 100°F (38°C), operating on 60 Hz power supply.

<sup>2</sup> Refer to dryer data plate for refrigerant charge.

**ELECTRICAL DATA**

MODEL	Power Supply			Power Consumption (kW)	Refrigerant
	Voltage	Phase	Hz		
DFX 1.1	115	1	60	0.54	R-134a
DFX 1.2	115	1	60	0.62	
DFX 1.5	230	1	60	0.85	R-407c
DFX 2.1	230	1	60	1.32	
DFX 3.1	460	3	60	1.99	
DFX 4.1	230	1	60	2.54	
DFX 4.5 <sup>1</sup>	460	3	60	3.23	
DFX 5.5 <sup>1</sup>	460	3	60	3.42	

**ENGINEERING DATA**

<b>MINIMUM - MAXIMUM OPERATING CONDITIONS</b>	<b>ALL MODELS</b>
Min.-Max. Inlet Air Pressure (compressed air at inlet to dryer)	43.5 - 232 psig (3 - 16 bar)
Min.-Max. Inlet Air Temperature (compressed air at inlet to dryer)	39°F - 122°F (4°C - 50°C)
Min.-Max. Ambient Temperature	36°F - 113°F (2°C - 45°C)

**REFRIGERANT PRESSURE SWITCH SETTINGS**

<b>Refrigerant Compressor Control</b>			
<b>High Pressure Switch Setting</b>			
<b>Model</b>	<b>Refrigerant</b>	<b>Cut-Out psig (barg)</b>	<b>Cut-In (psig)</b>
<b>DFX 1.1</b> <b>DFX 1.2</b>	R-134a	304 psig (21 bar)	Manual Reset
<b>DFX 1.5</b> <b>DFX 2.1</b> <b>DFX 3.1</b> <b>DFX 4.1</b> <b>DFX 4.5</b> <b>DFX 5.5</b>	R-407c	406 psig (28 bar)	Manual Reset

**CORRECTION FACTORS (MULTIPLIERS)**

<b>Air Inlet Temperature °F (°C)</b>	<b>Multiplier</b>	<b>Air Inlet Pressure psig (barg)</b>	<b>Multiplier</b>	<b>Ambient Air Temperature °F (°C)</b>	<b>Multiplier</b>
80°F (27°C)	1.46	75 psig (5.2 bar)	0.86	80°F (27°C)	1.12
90°F (32°C)	1.23	100 psig (6.9 bar)	1.00	90°F (32°C)	1.06
100°F (38°C)	1.00	120 psig (8.3 bar)	1.04	100°F (38°C)	1.00
110°F (43°C)	0.82	150 psig (10.3 bar)	1.09	110°F (43°C)	0.83
120°F (49°C)	0.68	225 psig (15.5 bar)	1.15	120°F (49°C)	0.68

**DEW POINT LEVEL RANGE**

<b>Dew Point Level</b>	<b>Temperature Range</b>	<b>Color</b>
<b>Lv 5</b>	Over 63°F (17°C)	Red
<b>Lv 4</b>	55°F - 61°F (13°C - 16°C)	Orange
<b>Lv 3</b>	48°F - 54°F (9°C - 12°C)	Green
<b>Lv 2</b>	39°F - 46°F (4°C - 8°C)	Green
<b>Lv 1</b>	Under 39°F (4°C)	Blue

**DRAWINGS: GENERAL ARRANGEMENT**

Figure 5A  
Model: DFX 1.1

MODEL	DIMENSIONS, INCHES (MM)											INLET/OUTLET CONNECTIONS	WEIGHT Lb. (kg)
	A	B	C	D	E	F	G	H	I	J	K		
DFX 1.1	4.69 (119)	4.97 (126.2)	8.41 (213.5)	19.20 (487.7)	14.27 (362.4)	29.58 (751.2)	12.75 (324)	23.72 (602.5)	3.39 (86.2)	15.40 (391.2)	22.14 (562.4)	1" NPT	120 (54.5)

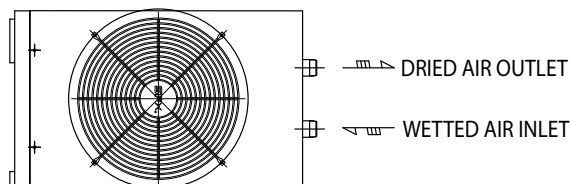

**TOP VIEW**

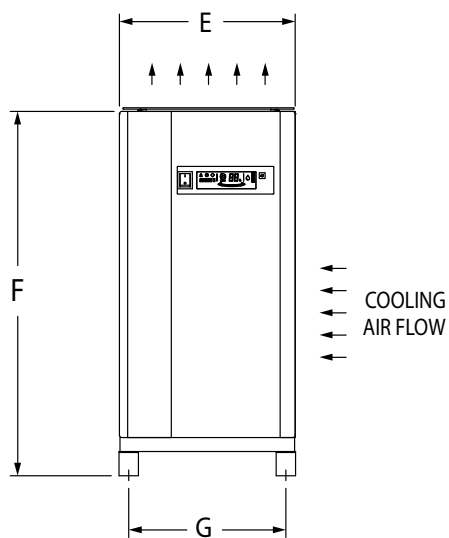

**FRONT VIEW**

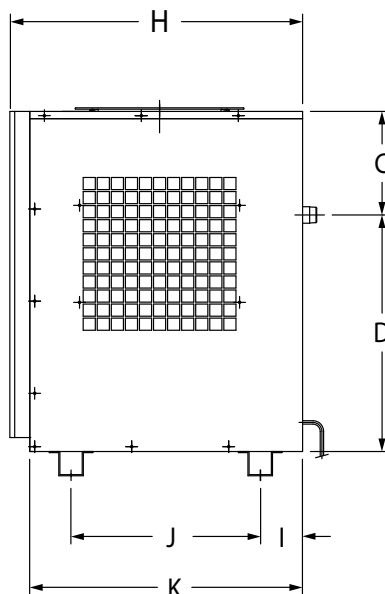

**RIGHT SIDE VIEW**

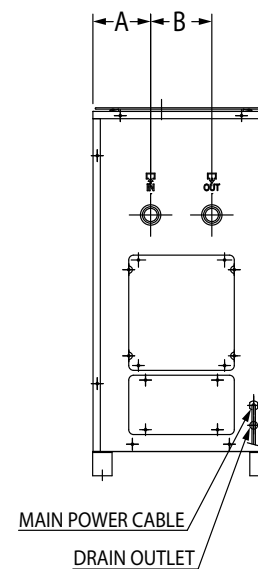

**REAR VIEW**

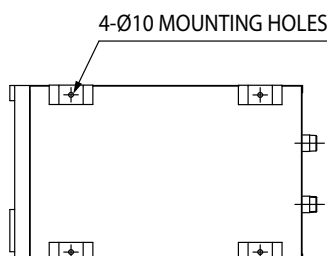

**FOOT PRINT**

**DRAWINGS: GENERAL ARRANGEMENT**

Figure 5B  
Model: DFX 1.2

MODEL	DIMENSIONS, INCHES (MM)											INLET/OUTLET CONNECTIONS	WEIGHT Lb. (kg)
	A	B	C	D	E	F	G	H	I	J	K		
DFX 1.2	3.41 (86.5)	4.97 (126.2)	6.77 (172)	19.25 (489.2)	14.29 (363)	28 (711.2)	12.76 (324)	30.76 (781.3)	5.56 (141.2)	19.29 (490)	29.18 (741.2)	1" NPT	147 (66.5)

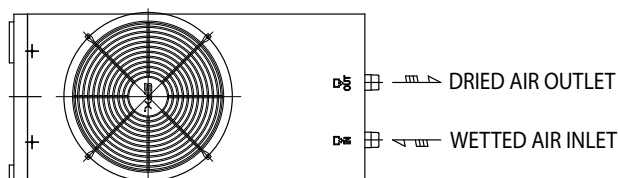

**TOP VIEW**

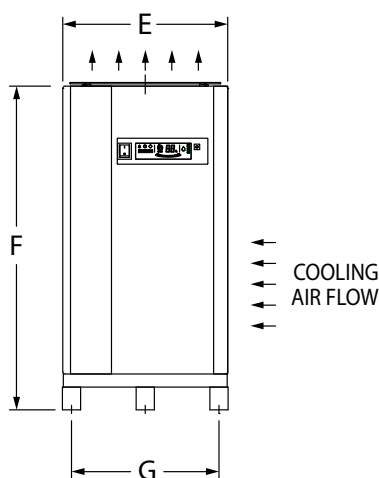

**FRONT VIEW**

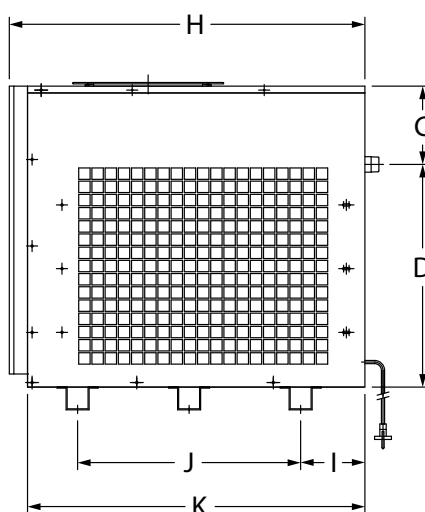

**RIGHT SIDE VIEW**

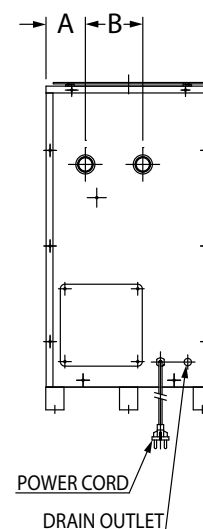

**REAR VIEW**

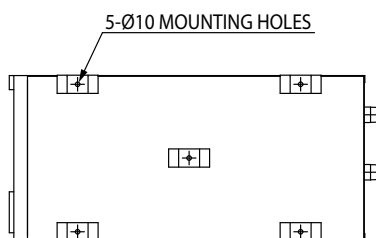

**FOOT PRINT**

**DRAWINGS: GENERAL ARRANGEMENT**

Figure 5C  
Models: DFX 1.5, DFX 2.1

MODEL	DIMENSIONS, INCHES (MM)											INLET/OUTLET CONNECTIONS	WEIGHT Lb. (kg)
	A	B	C	D	E	F	G	H	I	J	K		
DFX 1.5	4.86 (123.5)	7.86 (199.6)	3.63 (92)	24.38 (619.2)	17.44 (443)	29.97 (761.2)	15.91 (404)	35.50 (901.3)	3.39 (86.2)	27.16 (690)	33.91 (861.2)	2" NPT	188.5 (85.5)
DFX 2.1	4.86 (123.5)	7.86 (199.6)	3.63 (92)	24.38 (619.2)	17.44 (443)	29.97 (761.2)	15.91 (404)	37.85 (961.3)	3.39 (86.2)	29.53 (750)	36.27 (921.2)	2" NPT	217 (98.5)

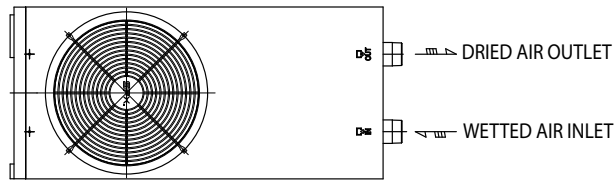

**TOP VIEW**

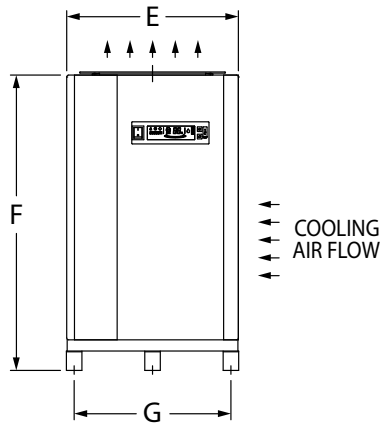

**FRONT VIEW**

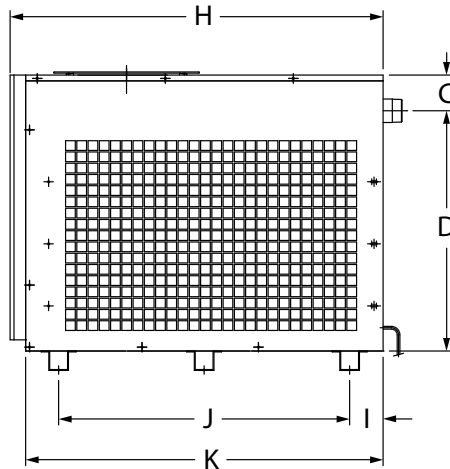

**RIGHT SIDE VIEW**

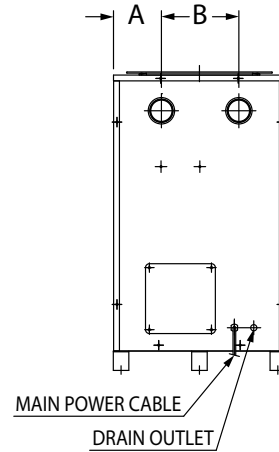

**REAR VIEW**

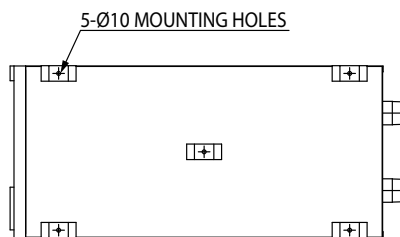

**FOOT PRINT**

**DRAWINGS: GENERAL ARRANGEMENT**

Figure 5D  
Models: DFX 3.1, DFX 4.1

MODEL	DIMENSIONS, INCHES (MM)											INLET/OUTLET CONNECTIONS	WEIGHT Lb. (kg)
	A	B	C	D	E	F	G	H	I	J	K		
DFX 3.1	4.86 (123.5)	7.86 (199.6)	8.31 (211.2)	25.59 (650)	19.41 (493)	35.88 (911.2)	17.88 (454)	43.75 (1111.3)	3.39 (86.2)	35.43 (900)	42.17 (1071.2)	2" NPT	324 (147)
DFX 4.1	4.86 (123.5)	8.58 (218)	8.35 (212)	25.56 (649.2)	19.41 (493)	35.88 (911.2)	17.88 (454)	43.75 (1111.3)	3.39 (86.2)	35.43 (900)	42.17 (1071.2)	2" NPT	335 (152)

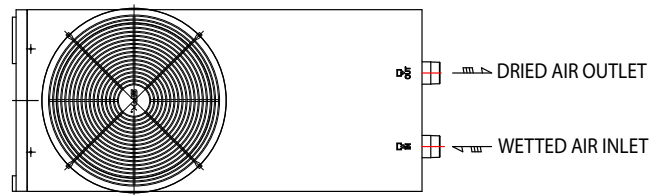

**TOP VIEW**

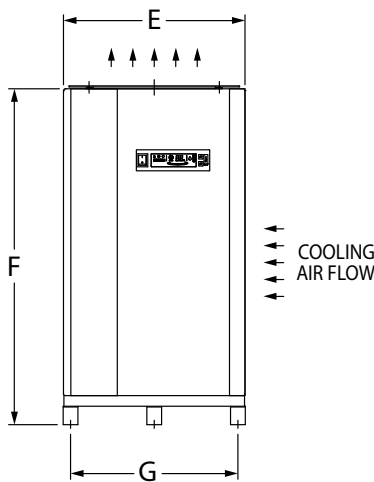

**FRONT VIEW**

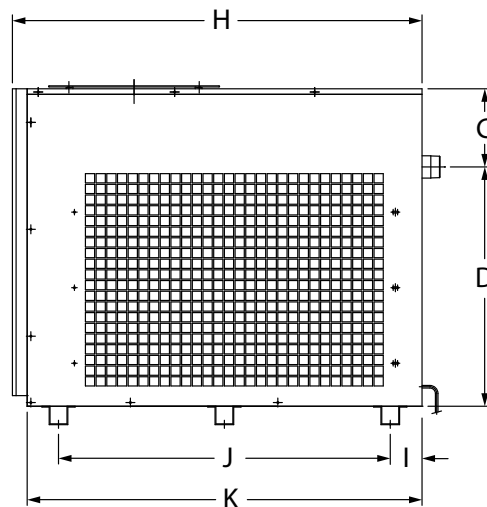

**RIGHT SIDE VIEW**

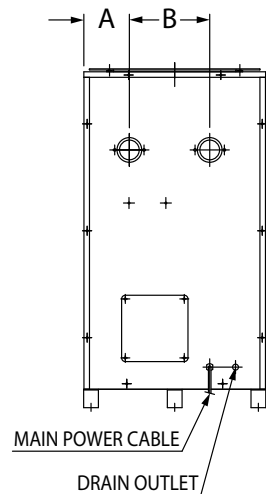

**REAR VIEW**

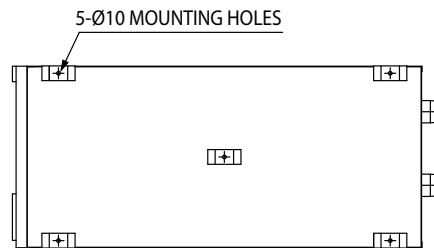

**FOOT PRINT**

**DRAWINGS: GENERAL ARRANGEMENT**

Figure 5E  
Models: DFX 4.5, DFX 5.5

MODEL	DIMENSIONS, INCHES (MM)												INLET/OUTLET CONNECTIONS	WEIGHT Lb. (kg)
	A	B	C	D	E	F	G	H	I	J	K	L		
DFX 4.5	4.87 (123.8)	8.58 (218)	9.79 (248.6)	30.83 (783)	19.43 (493.5)	40.61 (1031.6)	17.72 (450)	19.30 (490)	1.97 (50)	43.70 (1110)	47.64 (1210)	49.32 (1252.8)	2" NPT	366 (166)
DFX 5.5	4.87 (123.8)	8.58 (218)	9.78 (248.6)	30.83 (783)	19.43 (493.5)	40.61 (1031.6)	17.72 (450)	19.30 (490)	1.97 (50)	43.70 (1110)	47.64 (1210)	49.32 (1252.8)	2" NPT	396 (180)

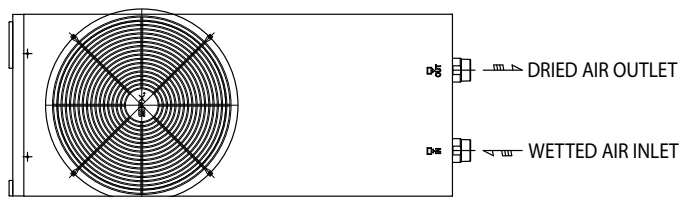

**TOP VIEW**

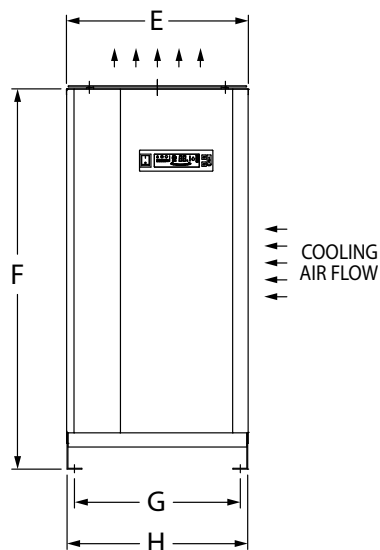

**FRONT VIEW**

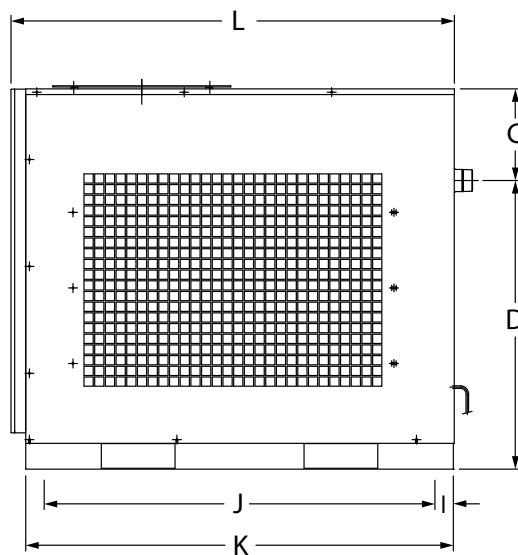

**RIGHT SIDE VIEW**

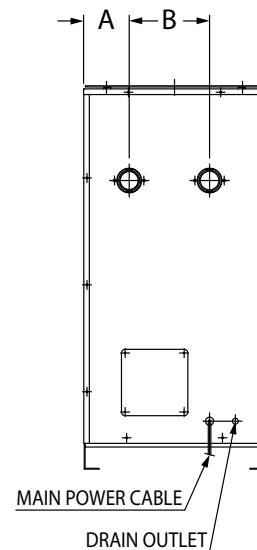

**REAR VIEW**

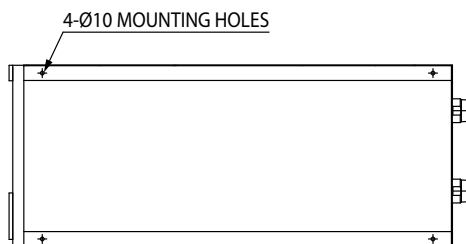

**FOOT PRINT**

**DRAWINGS: ELECTRICAL SCHEMATIC**

Figure 6A  
 Models: DFX 1.1, DFX 1.2 (115V/1PH/60Hz)

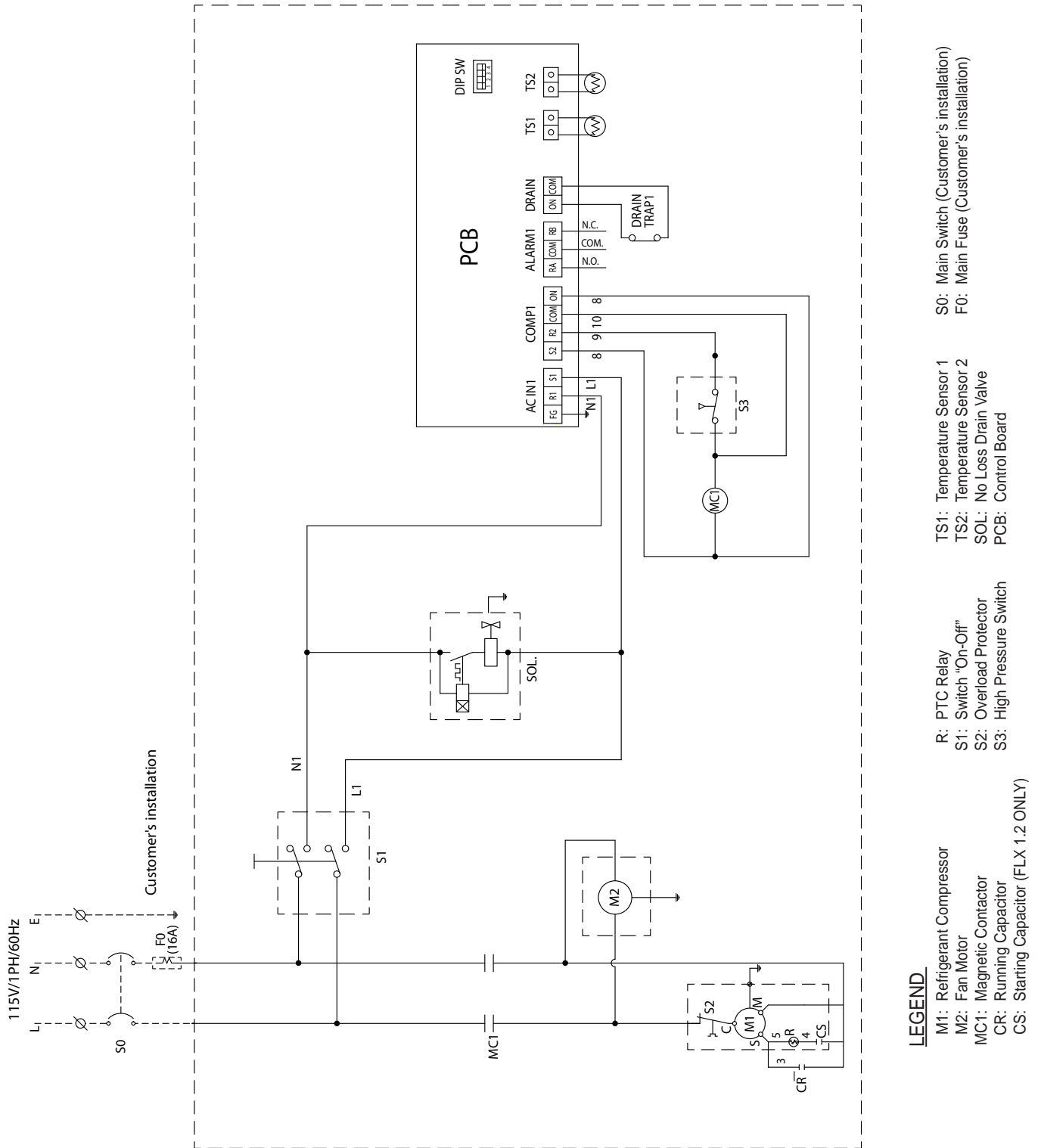

**DRAWINGS: ELECTRICAL SCHEMATIC**

Figure 6B  
Models: DFX 1.5, DFX 2.1, DFX 4.1 (230V/1Ph/60Hz)

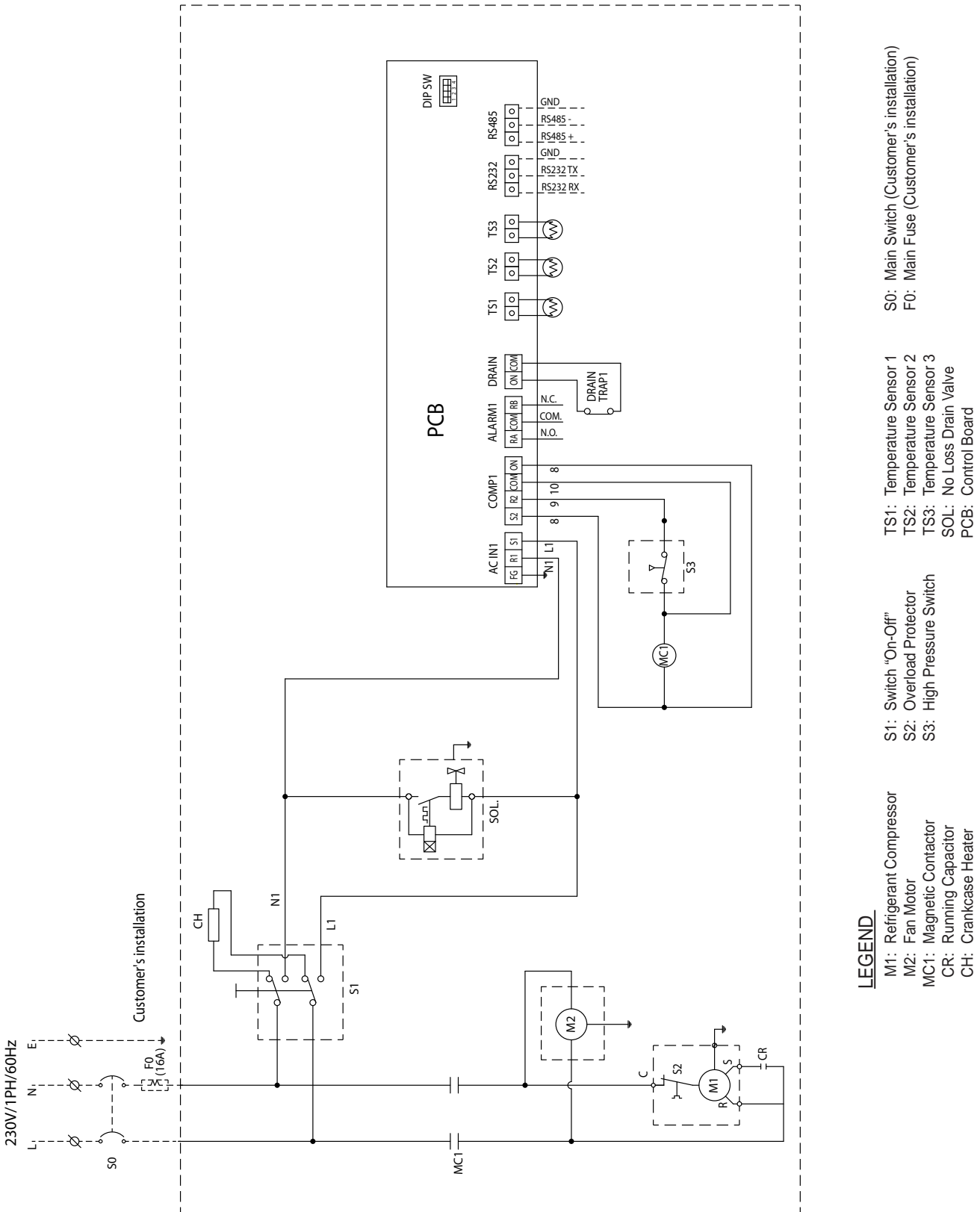

**LEGEND**

- M1: Refrigerant Compressor
- M2: Fan Motor
- MC1: Magnetic Contactor
- CR: Running Capacitor
- CH: Crankcase Heater
- S1: Switch "On-Off"
- S2: Overload Protector
- S3: High Pressure Switch
- TS1: Temperature Sensor 1
- TS2: Temperature Sensor 2
- TS3: Temperature Sensor 3
- SOL: No Loss Drain Valve
- PCB: Control Board
- S0: Main Switch (Customer's installation)
- F0: Main Fuse (Customer's installation)



**DRAWINGS: AIR AND REFRIGERANT FLOW SCHEMATIC**

Figure 7

Models: DFX 1.1, DFX 1.2, DFX 1.5, DFX 2.1, DFX 3.1, DFX 4.1, DFX 4.5, DFX 5.5

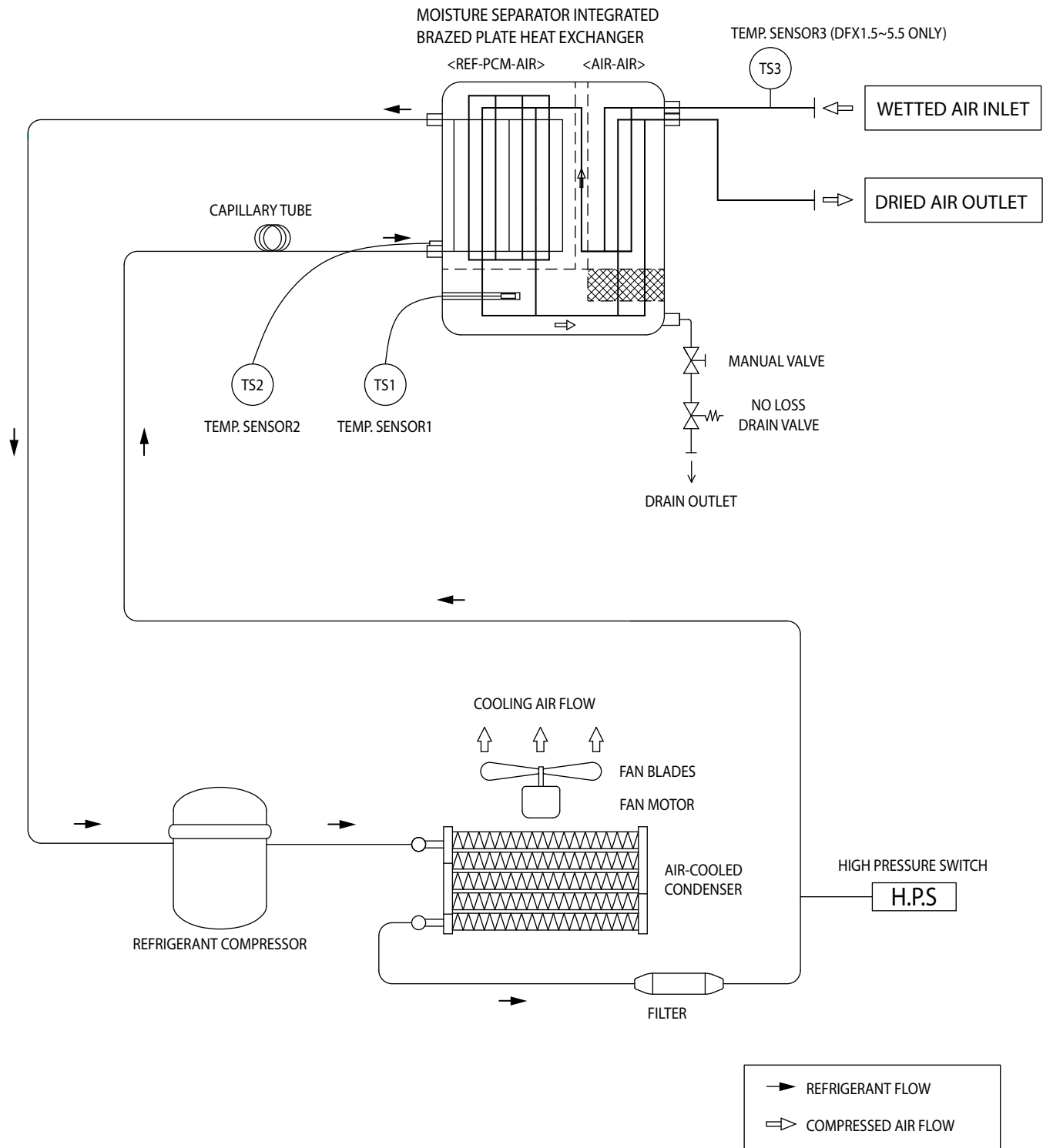

**REPLACEMENT PARTS**

Model: DFX 1.1

Models: DFX 1.2, DFX 1.5, DFX 2.1, DFX 3.1, DFX 4.1, DFX 4.5, DFX 5.5

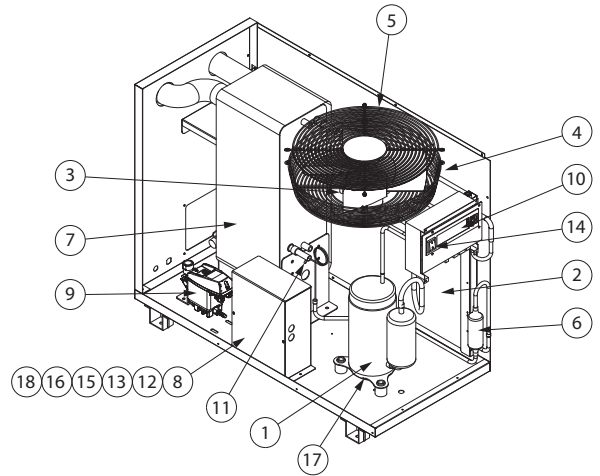
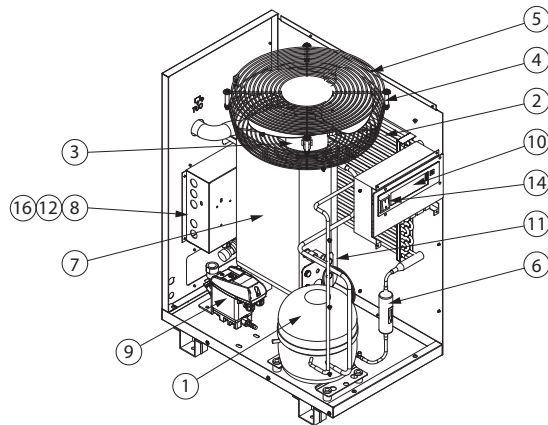

ID#	Part name	DFX 1.1	DFX 1.2	DFX 1.5	DFX 2.1	DFX 3.1	DFX 4.1	DFX 4.5	DFX 5.5
		(115V)	(115V)	(230V)	(230V)	(460V)	(230V)	(460V)	(460V)
1	Refrigerant Compressor	7440069	7440070	7433660	7433661	3093041	7433664	7439957	7440109
2	Condenser	7440044	7440045	7440110	7439968	7440111	7439967	7439967	7440112
3	Fan Motor	3161243	3161243	7433673	7433673	7440057	7440113	7440057	7439969
4	Fan Grill	7426017	7426017	7426018	7426018	—	7440046	—	—
5	Fan Grill (Ext.)	7440058	7440059	7440059	7440059	7440061	7440060	7440061	7440000
6	Filter Dryer	3142596	7433676	7433676	7433676	7433676	7433676	7433676	7433676
7	Plate Heat Exchanger	7440039	7440114	7440115	7440116	7440117	7440118	7440118	7440119
8	High Pressure Switch	3161273	3161273	7433678	7433678	7433678	7433678	7433678	7433678
9	No Loss Drain Valve	7440053	7440053	7440053	7440053	7440053	7440053	7440053	7440053
10	OPTi-Eco PCB+LCD	7440050	7440050	7440051	7440051	7440051	7440051	7440051	7440051
11	Temperature Sensor	7440054	7440054	7440055	7440055	7440056	7440056	7440056	7440056
12	Magnetic Contactor (Compressor)	7433697	7433697	7433697	7433697	3242864	7433698	3242864	3242864
13	Magnetic Contactor (Fan)	—	—	—	—	3242863	—	3242863	3242863
14	On/Off Switch	3209745	3209745	7440052	7440052	7440052	7440052	7440052	7440052
15	Start Capacitor	—	7433696	—	—	—	—	—	—
16	Run Capacitor	7440065	7433691	7433692	7433693	—	7433695	—	—
17	Crankcase Heater	—	—	7440132	7440066	7439996	7440067	7439996	7439996
18	Voltage Transformer	—	—	—	—	7439965	—	7439965	7439965

Phone: +1 724 745 8647  
 Email: deltech.amer.cs@spxflow.com  
 Web: www.spxflow.com/deltech

**MAINTENANCE KITS**

<b>Model</b>	<b>Kit Components</b>	<b>DFX 1.1</b>	<b>DFX 1.2</b>	<b>DFX 1.5</b>	<b>DFX 2.1</b>
Standard Kit	No Loss Drain Valve Repair Kit, Drain Cover	<b>DFXMK</b> (7461666)	<b>DFXMK</b> (7461666)	<b>DFXMK</b> (7461666)	<b>DFXMK</b> (7461666)
Standard Kit with Mounted Filtration	No Loss Drain Valve Repair Kit, Drain Cover, Prefilter Element, Afterfilter Element, Filter Drain Valve Repair Kit (2)	<b>DFX1.1-FPMK</b> (7461672)	<b>DFX1.2-FPMK</b> (7461673)	<b>DFX1.5-FPMK</b> (7440122)	<b>DFX2.1-FPMK</b> (7461674)

<b>Model</b>	<b>Kit Components</b>	<b>DFX 3.1</b>	<b>DFX 4.1</b>	<b>DFX 4.5</b>	<b>DFX 5.5</b>
Standard Kit	No Loss Drain Valve Repair Kit, Drain Cover	<b>DFXMK</b> (7461666)	<b>DFXMK</b> (7461666)	<b>DFXMK</b> (7461666)	<b>DFXMK</b> (7461666)
Standard Kit with Mounted Filtration	No Loss Drain Valve Repair Kit, Drain Cover, Prefilter Element, Afterfilter Element, Filter Drain Valve Repair Kit (2)	<b>DFX3.1-FPMK</b> (7440123)	<b>DFX4.1-FPMK</b> (7461675)	<b>DFX4.5-FPMK</b> (7461676)	<b>DFX5.5-FPMK</b> (7461677)

Phone: +1 724 745 8647  
 Email: [deltech.amer.cs@spxflow.com](mailto:deltech.amer.cs@spxflow.com)  
 Web: [www.spxflow.com/deltech](http://www.spxflow.com/deltech)

**WARRANTY**

The manufacturer warrants the product manufactured by it, when properly installed, operated, applied, and maintained in accordance with procedures and recommendations outlined in manufacturer's instruction manuals, to be free from defects in material or workmanship for a period as specified below, provided such defect is discovered and brought to the manufacturer's attention within the aforesaid warranty period.

The manufacturer will repair or replace any product or part determined to be defective by the manufacturer within the warranty period, provided such defect occurred in normal service and not as a result of misuse, abuse, neglect or accident. Normal maintenance items requiring routine replacement are not warranted. The warranty covers parts and labor for the warranty period unless otherwise specified. Repair or replacement shall be made at the factory or the installation site, at the sole option of the manufacturer. Any service performed on the product by anyone other than the manufacturer must first be authorized by the manufacturer.

Unauthorized service voids the warranty and any resulting charge or subsequent claim will not be paid. Products repaired or replaced under warranty shall be warranted for the unexpired portion of the warranty applying to the original product.

The foregoing is the exclusive remedy of any buyer of the manufacturer's product. The maximum damages liability of the manufacturer is the original purchase price of the product or part.

THE FOREGOING WARRANTY IS EXCLUSIVE AND IN LIEU OF ALL OTHER WARRANTIES, WHETHER WRITTEN, ORAL, OR STATUTORY, AND IS EXPRESSLY IN LIEU OF THE IMPLIED WARRANTY OF MERCHANTABILITY AND THE IMPLIED WARRANTY OF FITNESS FOR A PARTICULAR PURPOSE. THE MANUFACTURER SHALL NOT BE LIABLE FOR LOSS OR DAMAGE BY REASON OF STRICT LIABILITY IN TORT OR ITS NEGLIGENCE IN WHATEVER MANNER INCLUDING DESIGN, MANUFACTURE OR INSPECTION OF THE EQUIPMENT OR ITS FAILURE TO DISCOVER, REPORT, REPAIR, OR MODIFY LATENT DEFECTS INHERENT THEREIN.

THE MANUFACTURER, HIS REPRESENTATIVE OR DISTRIBUTOR SHALL NOT BE LIABLE FOR LOSS OF USE OF THE PRODUCT OR OTHER INCIDENTAL OR CONSEQUENTIAL COSTS, EXPENSES, OR DAMAGES INCURRED BY THE BUYER, WHETHER ARISING FROM BREACH OF WARRANTY, NEGLIGENCE OR STRICT LIABILITY IN TORT.

The manufacturer does not warrant any product, part, material, component, or accessory manufactured by others and sold or supplied in connection with the sale of manufacturer's products.

**Warranty Period**

Parts and labor for two (2) years from the date of shipment from the factory; heat exchangers are covered (parts only) for an additional three (3) years (total of five (5)). On units that manufacturer requests be returned to the factory, a one time removal/reinstallation labor allowance as noted in the Service Warranty Policies and Procedures Handbook will apply. Freight to the factory from the installation site and to the installation site from the factory will be paid by the manufacturer; means of transportation to be specified by manufacturer.

**AUTHORIZATION FROM THE SERVICE DEPARTMENT IS NECESSARY BEFORE MATERIAL IS RETURNED TO THE FACTORY OR IN-WARRANTY REPAIRS ARE MADE.**

**SERVICE DEPARTMENT: (724) 746-1100**

## FLEX Series

Refrigerated Type Compressed Air Dryers

Models: DFX 1.1, DFX 1.2, DFX 1.5,  
DFX 2.1, DFX 3.1, DFX 4.1,  
DFX 4.5, DFX 5.5

# SPXFLOW<sup>®</sup>

**SPX FLOW**

4647 S.W. 40th Avenue

Ocala, Florida 34474-5788 U.S.A.

P: (724) 745-8647

F: (724) 745-4967

E: [deltech.americas@spxflow.com](mailto:deltech.americas@spxflow.com)

[www.spxflow.com/deltech](http://www.spxflow.com/deltech)

Improvements and research are continuous at SPX FLOW, Inc.

Specifications may change without notice.

ISSUED 06/2017 Form No.: 7440063 Revision: D

COPYRIGHT ©2017 SPX FLOW, Inc.